

InGage Regulator



- Unique Internal Pressure Gauge
- Unique Field Adjustable Pressure Gauge
- Unique Dome Handle
- Unique Yoke Washer Seal
- Unique Swivel Yoke & Body
- Unique Glow in the Dark Flow Numbers
- Unique Dodecagon (12 sided) shape
- Unique Double Filter System
- Unique Thread Insert Design
- Unique Custom Laser Etching available
- MRI Compatible and Safe
- 16 Medical Gas configurations
- 14 Different Anodized Colors
- All Metal Construction, available in
 - Anodized Aluminum
 - Tri-Metal or 23k Gold Plated Brass
 - Stainless Steel
 - FDA CGMP (CFR 21, Parts 803-820)
- ISO13485
- CE Mark
- **Manufactured exclusively in the United States of America**



| Part Number | Description | List |
|---------------|---|--------|
| DR8033-7003P4 | CGA 870, 0-25 LPM, Hose Barb | 191.40 |
| DR8133-7003P4 | CGA 870, One DISS-1240 Check Valve, 0-25 LPM, Hose Barb | 202.40 |
| DR8333-7003P4 | CGA 870, Two DISS-1240 Check Valves, 0-25 LPM, Hose Barb | 213.40 |
| DR5103-6003 | CGA 540, One DISS Check Valve, Pressure Reducer, Plain Cap | 122.10 |
| DR5303-6003 | CGA 540, Two DISS Check Valves, Pressure Reducer, Plain Cap | 133.10 |
| DR5303-7003P4 | CGA 540, Two DISS-1240 Check Valves, 0-25 LPM, Hose Barb | 205.70 |

InGage Regulator for Medical Gases

- Including all the unique features of the InGage Regulator, Flotec has a complete offering of this extremely durable regulator for all Medical Gases listed below. All others are available on request.
- Shown with Hose Barbs except where noted, DISS fittings available for each Medical Gas
- Shown with CGA suggested colors, ISO colors for each gas available or non-gas specific option
- Shown with 0-25 LPM flow range accept were noted as PR only, other flows available

| Part Number | Gas | GGA | Description | CGA color | List |
|---------------|---------------------------------|-----------|---------------------------|---------------|--------|
| DR2002-7002P4 | None | | 1/4" FNPT | Silver | 216.70 |
| DRC002-7002P4 | Carbon Dioxide | CGA 320 | Hex Nut & Nipple | Silver | 272.80 |
| DRL002-7002P4 | Carbon Dioxide <7% & Oxygen Mix | CGA 880 | Yoke Assembly | Silver | 283.80 |
| DRT002-7002P4 | Carbon Dioxide <7% & Oxygen Mix | CGA 280 | Knurled Nut & Nipple | Silver | 215.60 |
| DR7002-7002P4 | Carbon Dioxide >7% & Oxygen Mix | CGA 940 | Yoke Assembly | Silver | 272.80 |
| DRQS07-6007 | Helium, DISS-1060 | CGA 890 | Hex Nut & Nipple, PR only | Brown | 246.40 |
| DRE037-7003P4 | Helium 70% & Oxygen 30% | CGA 890 | Yoke Swivel Body & Dome | Brown & Green | 228.80 |
| DRM037-7003P4 | Helium 80% & Oxygen 20% | CGA 890 | Yoke Swivel Body & Dome | Brown & Green | 228.80 |
| DRK007-7003P4 | Helium >80% & Oxygen Mix | CGA 930 | Yoke Assembly | Brown & Green | 278.30 |
| DRH007-7003P4 | Helium 60% & Oxygen 40% | CGA 280 | Knurled Nut & Nipple | Brown & Green | 221.10 |
| DRF007-7003P4 | Helium 70% & Oxygen 30% | CGA 280 | Knurled Nut & Nipple | Brown & Green | 221.10 |
| DRB007-7003P4 | Helium 80% & Oxygen 20% | CGA 280 | Knurled Nut & Nipple | Brown & Green | 221.10 |
| DR4004-7004P4 | Medical Air | CGA 346 | Knurled Nut & Nipple | Yellow | 220.00 |
| D0P004-7004P4 | Medical Air (4500 psi) | CGA 347 | Knurled Nut & Nipple | Yellow | 259.60 |
| DR9034-7004P4 | Medical Air | CGA 950 | Yoke Swivel Body & Dome | Yellow | 227.70 |
| DRA202-6002 | Medical Gas Mix, 1/8" FNPT | CGA 500 | Hex Nut & Nipple, PR only | Silver | 205.70 |
| DR3202-6002 | Medical Gas Mix, 1/8" FNPT | CGA 973 | Yoke Assembly, PR only | Silver | 232.10 |
| DRN202-6002 | Nitric Oxide, 1/8" FNPT | CGA 660 | Hex Nut & Nipple, PR only | Silver | 306.90 |
| DRR202-6002 | Nitric Oxide Mix, 1/8" FNPT | CGA 620 | Hex Nut & Nipple, PR only | Silver | 295.90 |
| DR1009-7009P4 | Nitrogen | CGA 580 | Hex Nut & Nipple | Black | 288.20 |
| DRD009-7009P4 | Nitrogen | CGA 960 | Yoke Assembly | Black | 288.20 |
| DRJM05-6005 | Nitrous Oxide, DISS-1040 | CGA 910 | Yoke Assembly, PR only | Blue | 170.50 |
| DRXM05-6005 | Nitrous Oxide, DISS-1040 | CGA 326 | Hex Nut & Nipple, PR only | Blue | 229.90 |
| DR6035-7005P4 | Nitrous Oxide & Oxygen Mix | CGA 965 | Yoke Swivel Body & Dome | Blue | 282.70 |
| DR5003-7003P4 | Oxygen | CGA 540 | Knurled Nut & Nipple | Green | 183.70 |
| DR8033-7003P4 | Oxygen | CGA 870 | Yoke Swivel Body & Dome | Green | 191.40 |
| DRU0F2-70F2P4 | Oxygen (58 psi (4 bar)) | BS 341 #3 | Hex Nut & Nipple | Silver | 267.30 |
| DRG0F2-70F2P4 | Oxygen (58 psi (4 bar)) | DIN 477-9 | Hex Nut & Nipple | Silver | 267.30 |
| DRS0F2-70F2P4 | Oxygen (58 psi (4 bar)) | Swedish | Hex Nut & Nipple | Silver | 267.30 |

InGage Regulator for Auxiliary Equipment

- Match Ambulance Flowmeter outlets with Regulator outlets for quicker transfers.
 - DISS Check Valve
 - Ohio Quick Disconnect
 - Chemetron Quick Disconnect
 - 1/8" FNPT Pipe Port
 - Stainless Steel Hansen (Canada)
 - SIS Check Valve (Australia)



| Part Number | Description | List |
|---------------|---|--------|
| DR8E33-7003P4 | CGA 870, One Ohio & One Check Valve, 0-25 LPM, Hose Barb | 298.10 |
| DR8Q33-7003P4 | CGA 870, One Chemetron & One Check Valve, 0-25 LPM, Hose Barb | 262.00 |

RW Series Regulator (Regulator with a Window)

- Unique Glow in the Dark Flow Numbers
- Unique Double Filter System
- Unique Thread Insert Design
- Unique selection of 14 Different Anodized Colors
- Low Profile Gauge
- MRI Compatible and Safe
- Anti-Blowout Design (no snap rings)
- Heavy Duty Service with Outstanding Impact Resistance
- Soft Seat, Finger Tight Post Valve Seal with Stay-Put Design
- All Metal Construction (available in Anodized Aluminum, Plated Brass, and Stainless Steel)
- 38 Flow Ranges with 12 Positions of Flow at 20 psi, 30 psi, 50 psi, 58 psi (4 bar) and 70 psi
- FDA CGMP (CFR 21, Parts 803-820), ISO13485, and CE Mark
- **Manufactured exclusively in the United States of America**



| Part Number | Description | List |
|-------------|---|--------|
| RR800-300P4 | CGA 870, 0-25 LPM, Hose Barb (Green) | 123.20 |
| RR810-300P4 | CGA 870, One DISS-1240 Check Valve, 0-25 LPM, Hose Barb (Green) | 134.20 |
| RR830-300P4 | CGA 870, Two DISS-1240 Check Valves, 0-25 LPM, Hose Barb (Green) | 145.20 |
| RR510-600 | CGA 540, One DISS Check Valve, Pressure Reducer, Plain Cap (Green) | 104.50 |
| RR510T-600 | CGA 540, Brass Body, One DISS Check Valve, Pressure Reducer, Plain Cap (Green) | 135.30 |
| RZ510-600 | CGA 540 w/ Knurled Nut, Gauge Port and Transducer port w/ 1/8" to 1/4" Adapter, One DISS Check Valve, Pressure Reducer, Plain Cap | 117.70 |



Flopac Integrated/Valve Regulator

- Unique High Pressure Shut Off for 3000 psi
- Unique Glow in the Dark Flow Numbers
- Unique Dodecagon (12 sided) shape
- Unique Double Filter System
- Unique Bent or Halo Style Handle Design
- Meets EN738-3 Specifications
- Anti-Blowout Design (no snap rings)
- MRI Compatible and Safe
- **Manufactured exclusively in the United States of America**



| Part Number | Description | List |
|--------------------|--|--------|
| FP2-xx-B03-7003PB | Bent Handle, One DISS-1240 Check Valve, 0-25 LPM, Hose Barb (2015 PSI CYL) | 150.00 |
| FPK-xx-B03-7003PB | Halo Handle, One DISS-1240 Check Valve, 0-25 LPM, Hose Barb (2015 PSI CYL) | 150.00 |
| FPE-xHx-B03-7003PB | Halo Handle, One DISS-1240 Check Valve, 0-25 LPM, Hose Barb (3000 PSI CYL) | 150.00 |

Mini Regulator

- Unique Glow in the Dark Flow Numbers
- Unique Double Filter System
- Unique Thread Insert Design
- Light Duty Service
- Low Profile Gauge
- MRI Compatible and Safe
- Anti-Blowout Design (no snap rings)
- Soft Seat, Finger Tight Post Valve Seal with Stay-Put Design
- All Metal Construction (available in Blue and Green Anodized Aluminum only)
- FDA CGMP (CFR 21, Parts 803-820), ISO9001, ISO13485, and CE Mark
- **Manufactured exclusively in the United States of America**



| Part Number | Description | List |
|---------------|---|--------|
| ML800-280P9 | CGA 870, 0-25 LPM, Hose Barb, T-Handle (Green) | 113.30 |
| ML8005-2805P9 | CGA 870, 0-25 LPM, Hose Barb, T-Handle (Blue) | 113.30 |
| ML803-280P9 | CGA 870, 0-25 LPM, Hose Barb, Dome Handle (Green) | 123.20 |
| ML8035-2805P9 | CGA 870, 0-25 LPM, Hose Barb, Dome Handle (Blue) | 123.20 |
| ML500-280P9 | CGA 540, 0-25 LPM, Hose Barb (Green) | 118.80 |
| ML5005-2805P9 | CGA 540, 0-25 LPM, Hose Barb (Blue) | 118.80 |
| ML500-663L | CGA 540, Pressure Reducer Cap w/ 12 lpm orifice (Green) | 93.50 |
| ML5005-6635L | CGA 540, Pressure Reducer Cap w/ 12 lpm orifice (Blue) | 93.50 |

Flowmeters

- Unique Glow in the Dark Flow Numbers
- Unique Filter System
- Unique high flow ranges (0-25, 0-30, 0-40, 0-60)
- Unique Resident Nipple Adapter Option
- Unique selection of 14 Different Anodized Colors
- Non-Gravity Sensitive and Vibration resistant
- All Metal construction
- MRI Compatible and Safe
- Power Take-Off Option available
- Heavy Duty Service with Outstanding Impact Resistance
- Anti-Blowout Design (no snap rings)
- 29 Flow Ranges with 12 Positions of Flow at 17 PSI, 30 PSI, 50 PSI, 58 PSI (4 bar) and 70 PSI
- FDA CGMP (CFR 21, Parts 803-820), ISO9001, ISO13485, and CE Mark
- **Manufactured exclusively in the United States of America**

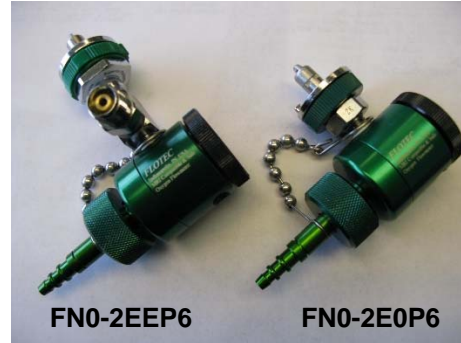

| Part Number | Description | List |
|-------------|---|--------|
| F10-2E0P6 | Ohio Inlet, 0-25 LPM DISS-1240 Outlet | 107.80 |
| F10-2EEP6 | Ohio Inlet, 0-25 LPM DISS-1240 Outlet, w/ DISS-1240 Check Valve Power Take-Off | 135.30 |
| FN0-2E0P6 | Ohio Inlet, 0-25 LPM DISS-1240 Outlet, w/ Resident Nipple Adapter | 116.60 |
| FN0-2EEP6 | Ohio Inlet, 0-25 LPM DISS-1240 Outlet, w/ Resident Nipple Adapter, w/ DISS-1240 Check Valve Power Take-Off | 144.10 |
| F70-210P4 | Ohio Inlet, Ceiling Mount, 0-25 LPM DISS-1240 Outlet | 107.80 |
| F70-21EP4 | Ohio Inlet, Ceiling Mount, 0-25 LPM DISS-1240 Outlet, w/ DISS-1240 Check Valve Power Take-Off | 135.30 |
| F10-2G0P6 | Chemetron Inlet, 0-25 LPM DISS-1240 Outlet | 107.80 |
| F10-2GEP6 | Chemetron Inlet, 0-25 LPM DISS-1240 Outlet, w/ DISS-1240 Check Valve Power Take-Off | 135.30 |
| FN0-2G0P6 | Chemetron Inlet, 0-25 LPM DISS-1240 Outlet, w/ Resident Nipple Adapter | 116.60 |
| FN0-2GEP6 | Chemetron Inlet, 0-25 LPM DISS-1240 Outlet, w/ Resident Nipple Adapter, w/ DISS-1240 Check Valve Power Take-Off | 144.10 |
| F90-210P4 | Chemetron Inlet, Ceiling Mount, 0-25 LPM DISS-1240 Outlet | 107.80 |
| F90-21EP4 | Chemetron Inlet, Ceiling Mount, 0-25 LPM DISS-1240 Outlet, w/ DISS-1240 Check Valve Power Take-Off | 135.30 |
| F10-2C0P6 | DISS-1240 Knurled Nut & Nipple Inlet, 0-25 LPM DISS-1240 Outlet | 82.50 |
| FN0-2C0P6 | DISS-1240 Knurled Nut & Nipple Inlet, 0-25 LPM DISS-1240 Outlet, w/ Resident Nipple Adapter | 91.30 |

Flowmeters on T or Y Blocks

- Unique double Flowmeter T-Block
- Unique Power Take Off Options
- Unique Glow in the Dark Flow Numbers
- Unique Filter System
- Unique Wide flow ranges (0-25, 0-30, 0-40, 0-60)
- Unique Resident Nipple Adapter Option
- Non-Gravity Sensitive
- Vibration resistance
- Custom Colors available
- All Metal construction
- MRI Compatible and Safe
- Heavy Duty Service, Outstanding Impact Resistance
- Anti-Blowout Design (no snap rings)
- Unique flow range option, Pediatric and Adult on either Flowmeter
 - “P6” - 12 position Flow range 0, 1, 2, 3, 4, 6, 8, 10, 12, 15, 20, 25
 - “D3” - 12 position Flow range 0, 1/32, 1/16, 1/8, 1/4, 1/2, 3/4, 1, 1-1/2, 2, 3, 4
- FDA CGMP (CFR 21, Parts 803-820), ISO9001:2008. ISO13485:2003
- **Manufactured exclusively in the United States of America**

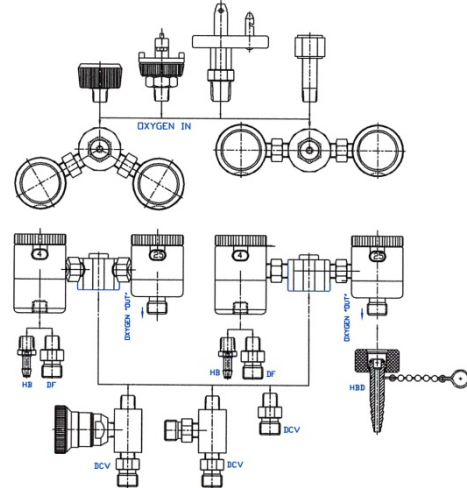

| Part Number | Description | List |
|-------------|--|--------|
| T10-2E0P6P6 | Ohio Inlet, 2 each 0-25 LPM DISS-1240 Outlet on T | 195.80 |
| T10-BE0P6P6 | Ohio Inlet, 2 each 0-25 LPM DISS-1240 Outlet on Y | 215.60 |
| T10-2EEP6P6 | Ohio Inlet, 2 each 0-25 LPM DISS-1240 Outlet on T, w/ DISS-1240 Check Valve Power Take Off on the Centerline of the T Block | 223.30 |
| TN0-2EEP6P6 | Ohio Inlet, 2 each 0-25 LPM DISS-1240 Outlet on T, w/ Two Resident Nipple Adapters, w/ DISS-1240 Check Valve Power Take Off on the Centerline of the T Block | 232.10 |
| T10-2E0D3P6 | Ohio Inlet, 1 each 0-4 LPM Pediatric, 1 each 0-25 LPM DISS-1240 Outlet on the T | 211.20 |
| T10-2EED3P6 | Ohio Inlet, 1 each 0-4 LPM Pediatric, 1 each 0-25 LPM DISS-1240 Outlet, w/ DISS-1240 Check Valve Power Take Off on the Centerline of the T Block | 238.70 |
| TN0-2EEP6P6 | Ohio Inlet, 2 each 0-25 LPM DISS-1240 Outlet on T, w/ Two Resident Nipple Adapters, w/ DISS-1240 Check Valve Power Take Off on the Centerline of the T Block | 232.10 |

| Part Number | Description | List |
|-------------|---|--------|
| T10-2G0P6P6 | Chemetron Inlet, 2 each 0-25 LPM DISS-1240 Outlet on T | 195.80 |
| T10-BG0P6P6 | Chemetron Inlet, 2 each 0-25 LPM DISS-1240 Outlet on Y | 215.60 |
| T10-2GEP6P6 | Chemetron Inlet, 2 each 0-25 LPM DISS-1240 Outlet on T, w/ DISS-1240 Check Valve Power Take Off on the Centerline of the T Block | 223.30 |
| TN0-2GEP6P6 | Chemetron Inlet, 2 each 0-25 LPM DISS-1240 Outlet on T, w/ Two Resident Nipple Adapters, w/ DISS-1240 Check Valve Power Take Off on the Centerline of the T Block | 232.10 |
| T10-2G0D3P6 | Chemetron Inlet, 1 each 0-4 LPM Pediatric, 1 each 0-25 LPM DISS-1240 Outlet on the T | 211.20 |
| T10-2GED3P6 | Chemetron Inlet, 1 each 0-4 LPM Pediatric, 1 each 0-25 LPM DISS-1240 Outlet, w/ DISS-1240 Check Valve Power Take Off on the Centerline of the T Block | 238.70 |
| TN0-2GEP6P6 | Chemetron Inlet, 2 each 0-25 LPM DISS-1240 Outlet on T, w/ Two Resident Nipple Adapters, w/ DISS-1240 Check Valve Power Take Off on the Centerline of the T Block | 232.10 |

Mass Casualty Assemblies

The assembly provides for the rapid triage deployment of six (0 to 25 LPM) Flowmeters or ten (0 to 15 LPM) Flowmeters that can run off the Ambulances onboard oxygen system. This provides the flexibility of individually controlling each patient's LPM requirement. The All-Metal Flowmeters are extremely durable and are non-gravity sensitive. The entire system can be run off any 50 PSI oxygen source capable of delivering 150 LPM.

Custom Designs available

- Unique 20 foot leader hose provides clearance from the ambulance before the first independent flowmeter
- Unique 6 foot spaces between each flowmeter to provide space to treat each patient with 50 foot overall length
- Unique 2 way swivel Tee configuration
- Unique low (-40 F) temperature hose rating
- Unique lanyards at each flowmeter for hanging on IV poles or wall brackets
- Includes a compact canvas or hard sided carrying case
- Unique Optional DISS 1204 Check Valves for powering a ventilator, aspirator or CPAP
- Unique Optional Drop Hoses available for Mobile Shelter / Hospital applications.
- Includes CGA540 pressure reducing regulator for attachment to large volume cylinder
- **Manufactured exclusively in the United States of America**



MCA-226P7-205X0



Live Swivel Tee



F5E-270P7

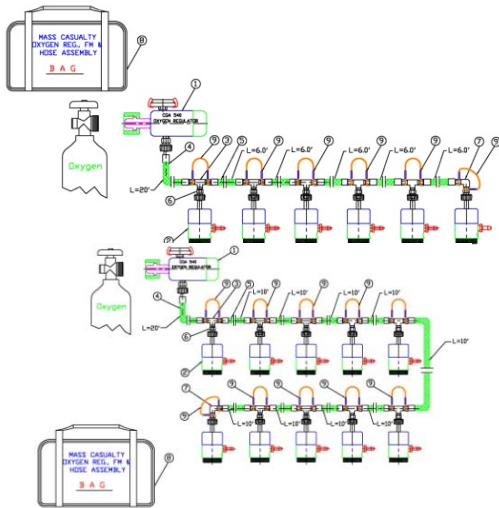

| Part Number | Description | List |
|----------------------------|--|---------|
| MCA-126P7-205X0 (shown) | 20 foot leader, six (0-25) flowmeters | 1542.22 |
| MCA-126P7-20FX0 | 20 foot leader, six (0-25) flowmeters w/ swivel T's | 1631.32 |
| MCA-226P7-20FX0 | 20 foot leader, six (0-25) flowmeters w/ swivel T's, w/ InGage Regulator | 1650.68 |

| Part Number | Description | List |
|----------------------------|--|---------|
| MCA-15JM5-20910 (shown) | 20 foot leader, ten (0-15) flowmeters | 2525.16 |
| MCA-15JM5-20K10 | 20 foot leader, ten (0-15) flowmeters w/ swivel T's | 2685.54 |
| MCA-25JM5-20K10 | 20 foot leader, ten (0-15) flowmeters w/ swivel T's, w/ InGage Regulator | 2704.90 |

Multitorr, Mass Casualty Manifolds

- Unique laser engraved Instructions For Use
- Unique all metal construction
- Unique Brass thread insert on Resident Nipple Adapter
- Unique Swivel feature on Resident Nipple Adapter
- **Manufactured exclusively in the United States of America**

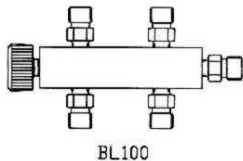

BL100



BL101

| Part Number | Description | List |
|-------------|--|--------|
| BL100 | One DISS-1240 Female Inlet, five DISS-1240 Male Check Valve Outlets | 95.00 |
| BL101 | One DISS-1240 Female Inlet, five DISS-1240 Male Check Valve Outlets mounted at 45 degrees | 130.00 |
| BL151 | One DISS-1240 Male Check Valve Inlet, five DISS-1240 Male Check Valve Outlets | 90.00 |
| BL151-5x6 | One DISS-1240 Male Check Valve Inlet, five DISS-1240 Male Check Valve Outlets with five Resident Nipple adapters with 6 LPM orifices | 172.50 |

| Part Number | Description | List |
|-------------|--|--------|
| BL300 | One DISS-1240 Female Inlet, Seven DISS-1240 Male Check Valve Outlets | 145.00 |
| BL301 | One DISS-1240 Female Inlet, Seven DISS-1240 Male Check Valve Outlets mounted at 45 degrees | 215.00 |

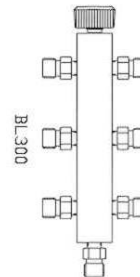

BL300



BL301



| Part Number | Description | List |
|-----------------|---|---------|
| BL500-FD0-2V0P4 | Multitorr Stand w/ 7 Horizontal Flowmeters w/ hose barbs mounted at 45 degrees, Female DISS-1240 swivel inlet | 1223.00 |
| BL500-F10-320M3 | Multitorr Stand w/ 7 Vertical Flowmeters w/ male DISS-1240, Female DISS-1240 swivel inlet | 1175.00 |
| BML750 | Canvas Bag Double Zipper Double Handle | 126.50 |

Resident Nipple Adapters

- ALL Metal Construction for Durability and Reliability
- Knurled Nut Swivels over Nipple for ease of use and prevents tube kinks
- O-ring seal for maximum leak prevention
- Stainless Steel chain and connecting ring to enhance ease of use and to prevent loss
- 2- 1/2" Standard chain length with other lengths available
- Three Barbs for use with a wide variety of tubing
- All adapters are cleaned for oxygen service
- Available in Seven different Colors of Anodized Aluminum Knurled Nuts for easy identification of different flows
- Available with fixed flow orifices of 0.5 LPM to 25 LPM
- Flow orifices available in 20 psi, 50 psi and 58 psi
- **Manufactured exclusively in the United States of America**

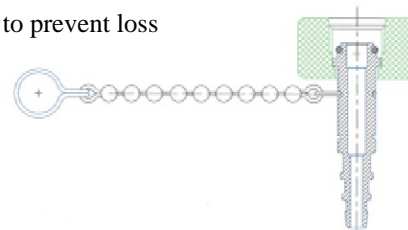

| Part Number | Description | List |
|-------------|--|-------|
| HBD22 | Green Hose Barb and Silver Knurled Nut w/ 2-1/2" Chain | 16.00 |
| HBD2 | Green Hose Barb and Green Knurled Nut w/ 2-1/2" Chain | 16.00 |
| HBD24 | Green Hose Barb and Yellow Knurled Nut w/ 2-1/2" Chain | 16.00 |
| HBD25 | Green Hose Barb and Blue Knurled Nut w/ 2-1/2" Chain | 16.00 |
| HBD26 | Green Hose Barb and Red Knurled Nut w/ 2-1/2" Chain | 16.00 |
| HBD29 | Green Hose Barb and Black Knurled Nut w/ 2-1/2" Chain | 16.00 |
| HBD2A | Green Hose Barb and Purple Knurled Nut w/ 2-1/2" Chain | 16.00 |

Available without Chain Length or extra Chain Length

| Part Number | Description | List |
|-------------|--|-------|
| HBD0 | Green Hose Barb and Silver Knurled Nut no Chain | 12.00 |
| HBD2 | Green Hose Barb and Green Knurled Nut w/ 2-1/2" SS Chain | 16.00 |
| HBD44 | Green Hose Barb and Yellow Knurled Nut w/ 4" SS Chain | 22.00 |
| HBD65 | Green Hose Barb and Blue Knurled Nut w/ 6" SS Chain | 25.00 |
| HBD86 | Green Hose Barb and Red Knurled Nut w/ 8" SS Chain | 28.00 |
| HBD A9 | Green Hose Barb and Black Knurled Nut w/ 10" SS Chain | 31.00 |

Brass Orifice Insert for precise flow control

Available in 20 psi, 50 psi, or 4 BAR (58 psi)

| | |
|-------------------|----------------|
| HBD2-20-xx | 20 PSI |
| HBD2-50-xx | 50 PSI |
| HBD2-58-xx | 4 Bar (58 PSI) |

Flows indicated twice on Nut

Pressure indicated twice on

20 psi & 4 BAR (58 psi) only

| | |
|-------------------|-----------------|
| HBD2-50-2 | 2 LPM @ 50 PSI |
| HBD2-50-4 | 4 LPM @ 50 PSI |
| HBD2-50-6 | 6 LPM @ 50 PSI |
| HBD2-50-8 | 8 LPM @ 50 PSI |
| HBD2-50-10 | 10 LPM @ 50 PSI |

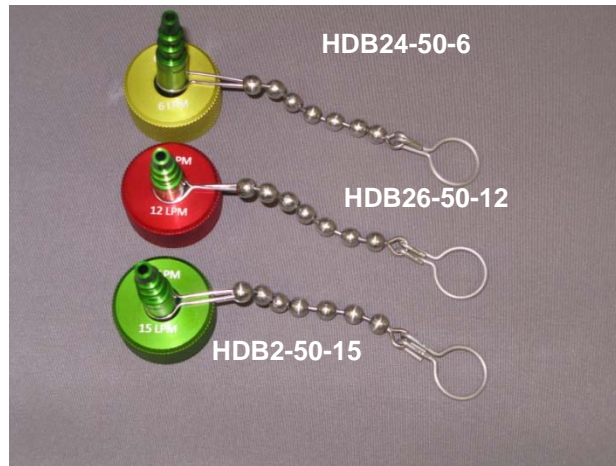

Ordering Information:

| 50 PSI Green Knurled Nut | | | 50 PSI Yellow Knurled Nut | | | 50 PSI Red Knurled Nut | | |
|--------------------------|------------------|-------|---------------------------|------------------|-------|------------------------|------------------|-------|
| HBD2-50-0.5 | 0.5 LPM @ 50 PSI | 21.00 | HBD24-50-0.5 | 0.5 LPM @ 50 PSI | 21.00 | HBD26-50-0.5 | 0.5 LPM @ 50 PSI | 21.00 |
| HBD2-50-1 | 1 LPM @ 50PSI | 18.00 | HBD24-50-1 | 1 LPM @ 50 PSI | 18.00 | HBD26-50-1 | 1 LPM @ 50 PSI | 18.00 |
| HBD2-50-2 | 2 LPM @ 50PSI | 18.00 | HBD24-50-2 | 2 LPM @ 50 PSI | 18.00 | HBD26-50-2 | 2 LPM @ 50 PSI | 18.00 |
| HBD2-50-3 | 3 LPM @ 50PSI | 18.00 | HBD24-50-3 | 3 LPM @ 50 PSI | 18.00 | HBD26-50-3 | 3 LPM @ 50 PSI | 18.00 |
| HBD2-50-4 | 4 LPM @ 50PSI | 18.00 | HBD24-50-4 | 4 LPM @ 50 PSI | 18.00 | HBD26-50-4 | 4 LPM @ 50 PSI | 18.00 |
| HBD2-50-6 | 6 LPM @ 50PSI | 18.00 | HBD24-50-6 | 6 LPM @ 50 PSI | 18.00 | HBD26-50-6 | 6 LPM @ 50 PSI | 18.00 |
| HBD2-50-8 | 8 LPM @ 50PSI | 18.00 | HBD24-50-8 | 8 LPM @ 50 PSI | 18.00 | HBD26-50-8 | 8 LPM @ 50 PSI | 18.00 |
| HBD2-50-10 | 10 LPM @ 50PSI | 18.00 | HBD24-50-10 | 10 LPM @ 50 PSI | 18.00 | HBD26-50-10 | 10 LPM @ 50 PSI | 18.00 |
| HBD2-50-12 | 12 LPM @ 50PSI | 18.00 | HBD24-50-12 | 12 LPM @ 50 PSI | 18.00 | HBD26-50-12 | 12 LPM @ 50 PSI | 18.00 |
| HBD2-50-15 | 15 LPM @ 50PSI | 18.00 | HBD24-50-15 | 15 LPM @ 50 PSI | 18.00 | HBD26-50-15 | 15 LPM @ 50 PSI | 18.00 |
| HBD2-50-20 | 20 LPM @ 50PSI | 18.00 | HBD24-50-20 | 20 LPM @ 50 PSI | 18.00 | HBD26-50-20 | 20 LPM @ 50 PSI | 18.00 |
| HBD2-50-25 | 25 LPM @ 50PSI | 18.00 | HBD24-50-25 | 25 LPM @ 50 PSI | 18.00 | HBD26-50-25 | 25 LPM @ 50 PSI | 18.00 |
| 20 PSI Green Knurled Nut | | | 20 PSI Yellow Knurled Nut | | | 20 PSI Red Knurled Nut | | |
| HBD2-20-1 | 1 LPM @ 20PSI | 18.00 | HBD24-20-1 | 1 LPM @ 20 PSI | 18.00 | HBD26-20-1 | 1 LPM @ 20 PSI | 18.00 |
| HBD2-20-2 | 2 LPM @ 20PSI | 18.00 | HBD24-20-2 | 2 LPM @ 20 PSI | 18.00 | HBD26-20-2 | 2 LPM @ 20 PSI | 18.00 |
| HBD2-20-4 | 4 LPM @ 20PSI | 18.00 | HBD24-20-4 | 4 LPM @ 20 PSI | 18.00 | HBD26-20-4 | 4 LPM @ 20 PSI | 18.00 |
| HBD2-20-8 | 8 LPM @ 20PSI | 18.00 | HBD24-20-8 | 8 LPM @ 20 PSI | 18.00 | HBD26-20-8 | 8 LPM @ 20 PSI | 18.00 |
| HBD2-20-12 | 12 LPM @ 20PSI | 18.00 | HBD24-20-12 | 12 LPM @ 20 PSI | 18.00 | HBD26-20-12 | 12 LPM @ 20 PSI | 18.00 |
| 58 PSI Green Knurled Nut | | | 58 PSI Yellow Knurled Nut | | | 58 PSI Red Knurled Nut | | |
| HBD2-58-1 | 1 LPM @ 58PSI | 19.00 | HBD24-58-1 | 1 LPM @ 58 PSI | 19.00 | HBD26-20-1 | 1 LPM @ 58 PSI | 19.00 |
| HBD2-58-2 | 2 LPM @ 58PSI | 19.00 | HBD24-58-2 | 2 LPM @ 58 PSI | 19.00 | HBD26-20-2 | 2 LPM @ 58 PSI | 19.00 |
| HBD2-58-4 | 4 LPM @ 58PSI | 19.00 | HBD24-58-4 | 4 LPM @ 58 PSI | 19.00 | HBD26-20-4 | 4 LPM @ 58 PSI | 19.00 |

FloGripp Post Valve Knob

The FloGripp replaces the Post Valve Toggle Handle

- Eliminates need for Post Valve Wrenches
- Provides easy ON and OFF control
- Eliminates risk from sharp surfaces on toggle style
- Simple to upgrade. Not necessary to remove valve from cylinder tank during installation.
- Broken Toggle Post Valves can be repurposed, saving \$\$\$\$\$

| Part Number | Description | List |
|-------------|----------------------------|-------|
| PVX30B | FloGripp Knob Assembly Kit | 26.00 |

